

DATE		8-8-2021		DO NOT SCALE DRAWING		DIMENSIONS ARE IN MM	
REV.	DRAWN	FB		TFT/Solutions			
1-01	APPROVED	FB					
MATERIAL				DESCRIPTION			
2mm RVS316				Assembly			
FINISH				PAGE NAME			
Verticaal geslepen				Resistive touch			
				DWG NO.		A3	
				SCALE:1:5		SHEET 1 OF 4	
				IPPC19-00			

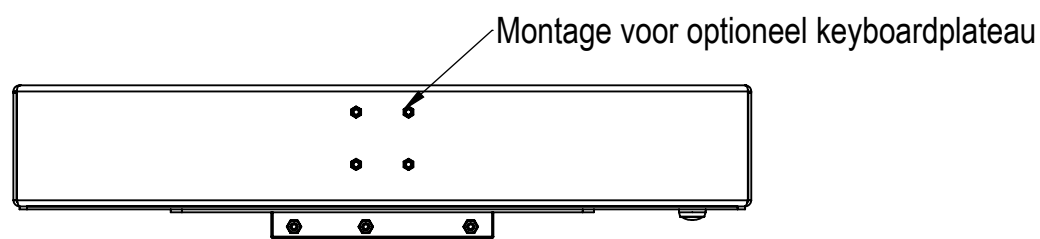

DATE		8-8-2021		DO NOT SCALE DRAWING		DIMENSIONS ARE IN MM	
REV.	DRAWN	FB		TFT/Solutions			
1-01	APPROVED	FB					
MATERIAL				DESCRIPTION			
2mm RVS316				Assembly			
FINISH				PAGE NAME			
Verticaal geslepen				IRtouch			
				DWG NO.		A3	
				SCALE:1:5		SHEET 2 OF 4	
				IPPC19-00			

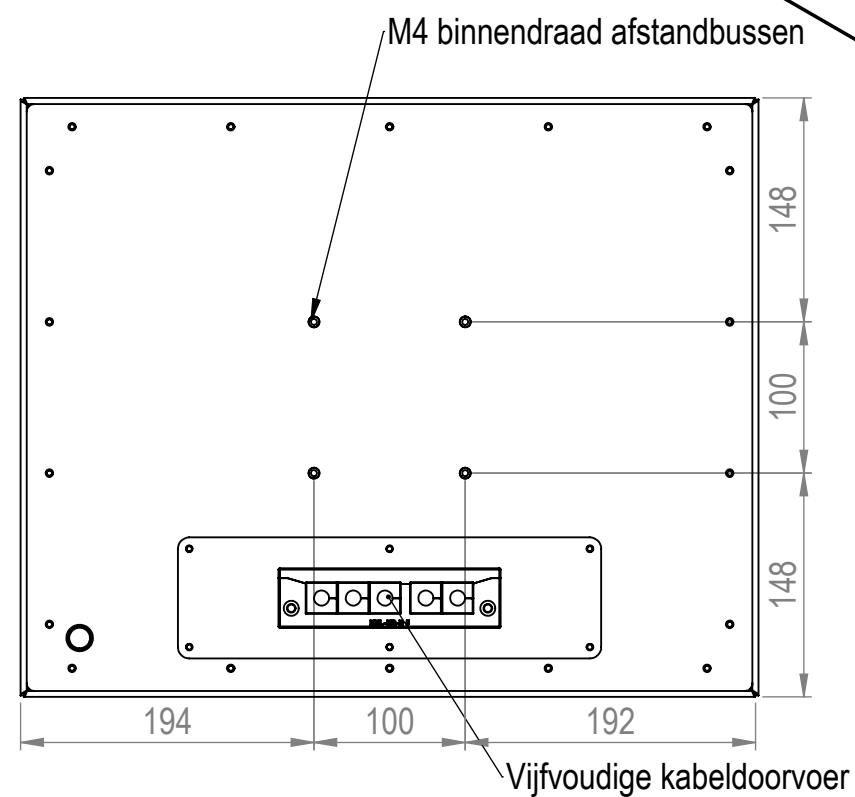
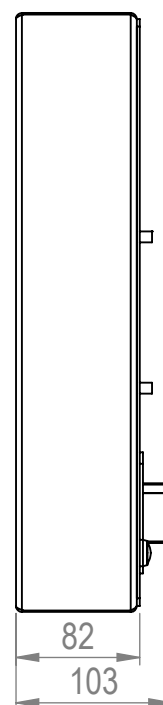
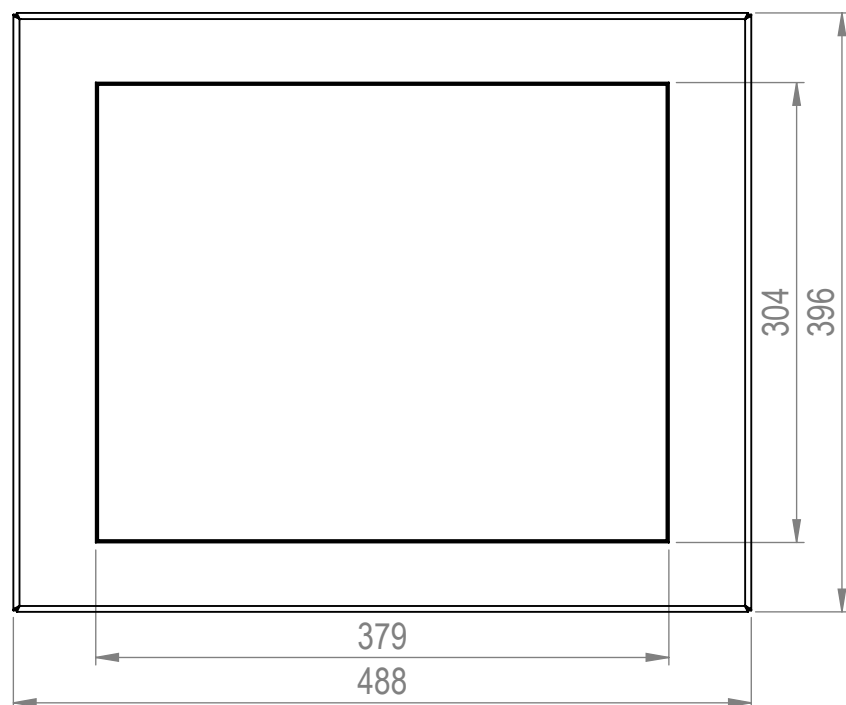
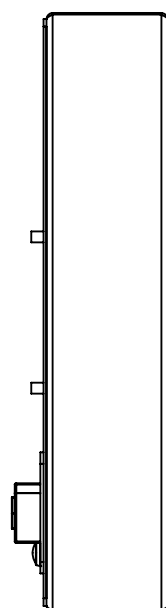
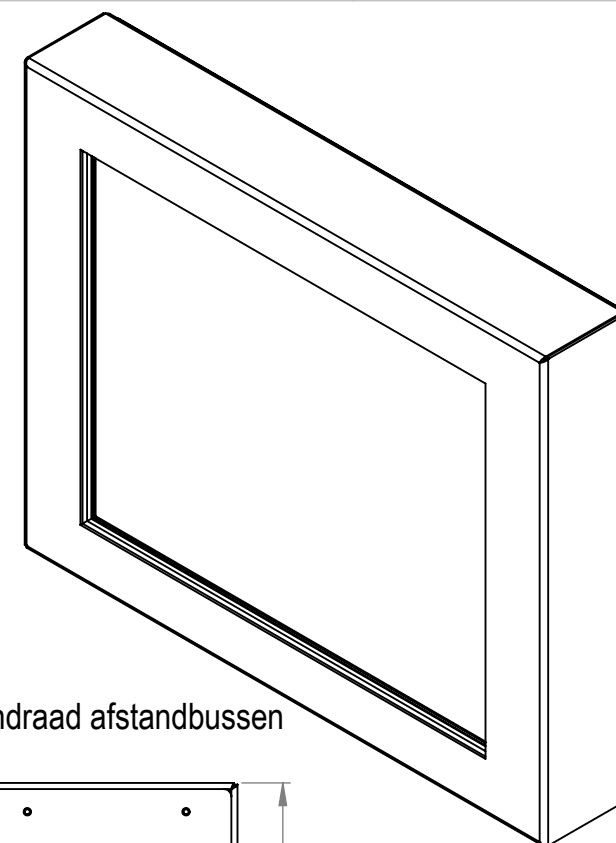
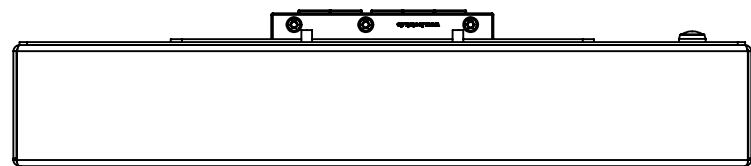
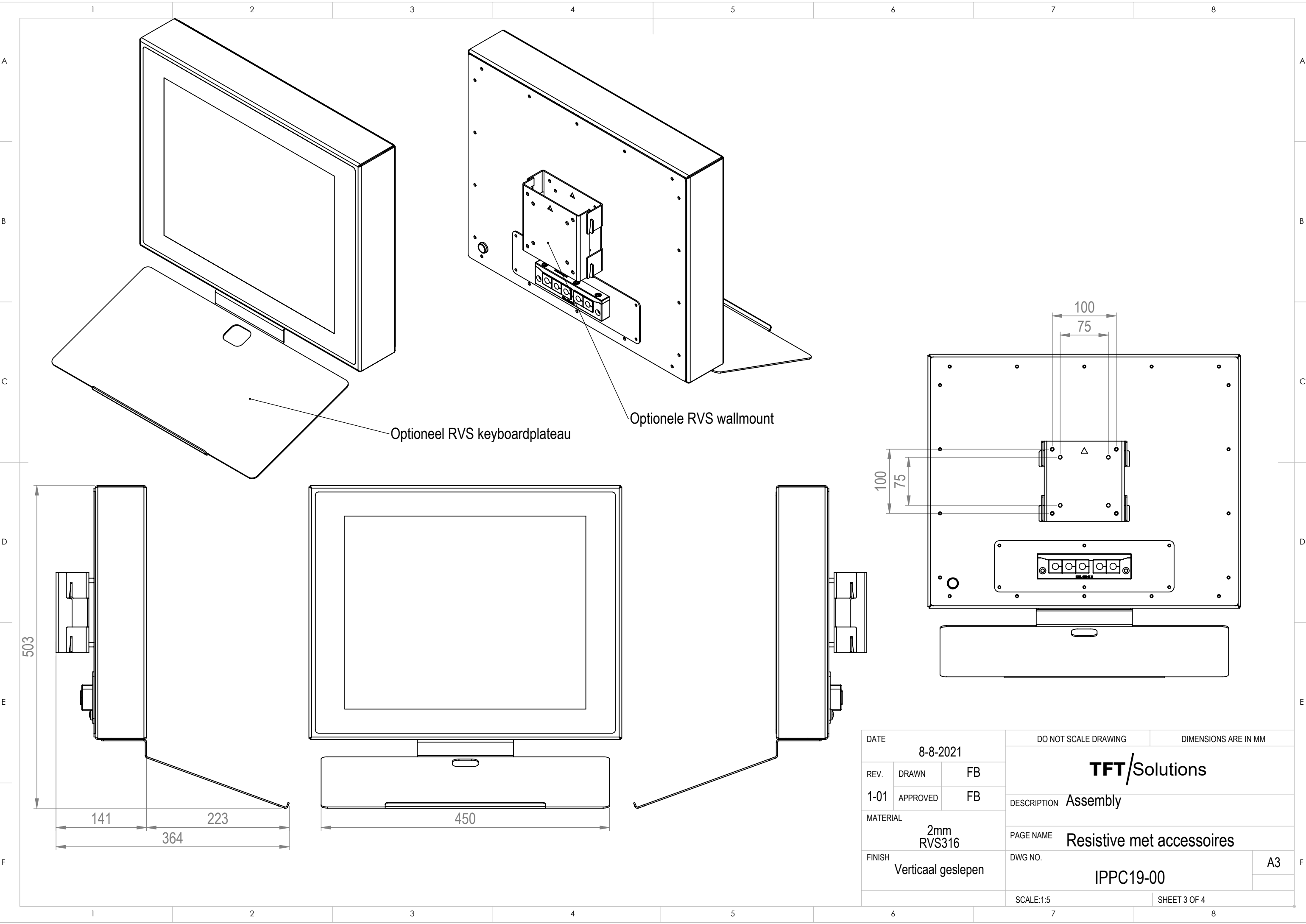

DATE		8-8-2021		DO NOT SCALE DRAWING		DIMENSIONS ARE IN MM	
REV.	DRAWN	FB		TFT/Solutions			
1-01	APPROVED	FB					
MATERIAL				DESCRIPTION			
2mm RVS316				Assembly			
FINISH				PAGE NAME			
Verticaal geslepen				Resistive met accessoires			
				DWG NO.		A3	
				SCALE:1:5		SHEET 3 OF 4	
				IPPC19-00			

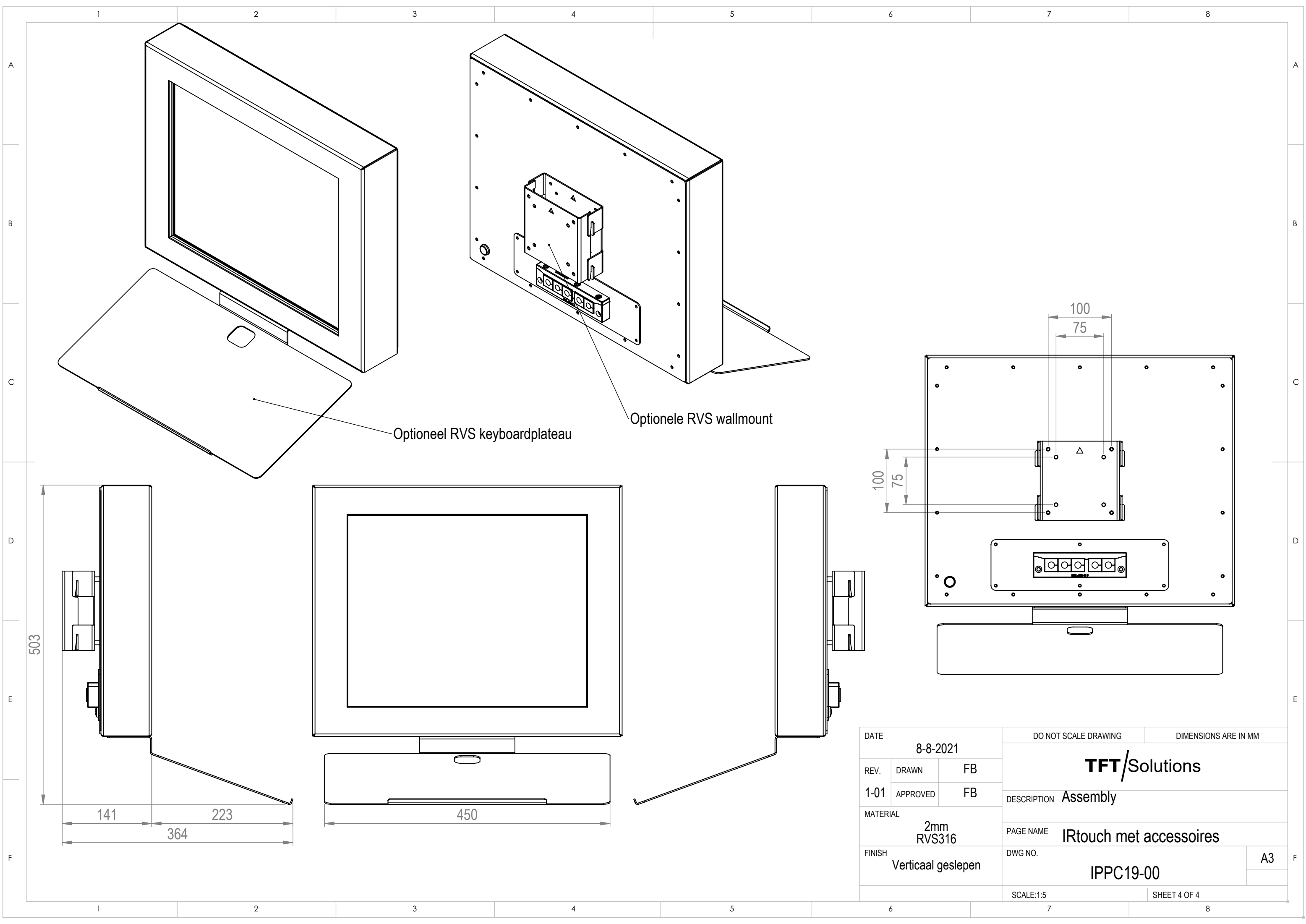

DATE		8-8-2021		DO NOT SCALE DRAWING		DIMENSIONS ARE IN MM	
REV.	DRAWN	FB		TFT/Solutions			
1-01	APPROVED	FB					
MATERIAL				DESCRIPTION			
2mm RVS316				Assembly			
FINISH				PAGE NAME			
Verticaal geslepen				IRtouch met accessoires			
				DWG NO.		A3	
				SCALE:1:5		SHEET 4 OF 4	
				IPPC19-00			