

2.54mm pitch for external power button

DATE		30-8-2023		DO NOT SCALE DRAWING		DIMENSIONS ARE IN MM	
REV.	DRAWN	FB		TFT/Solutions			
3	APPROVED	FB					
MATERIAL				DESCRIPTION			
				Assembly			
FINISH				PAGE NAME			
				R190-C4, Celeron J6412			
				DWG NO.			
				R190-00			
				SCALE:1:5		SHEET 1 OF 3	
						A3	

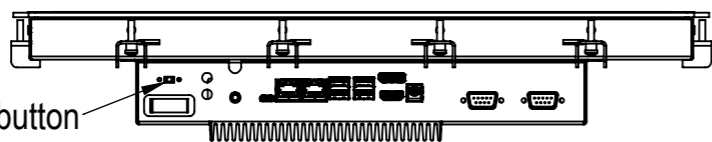
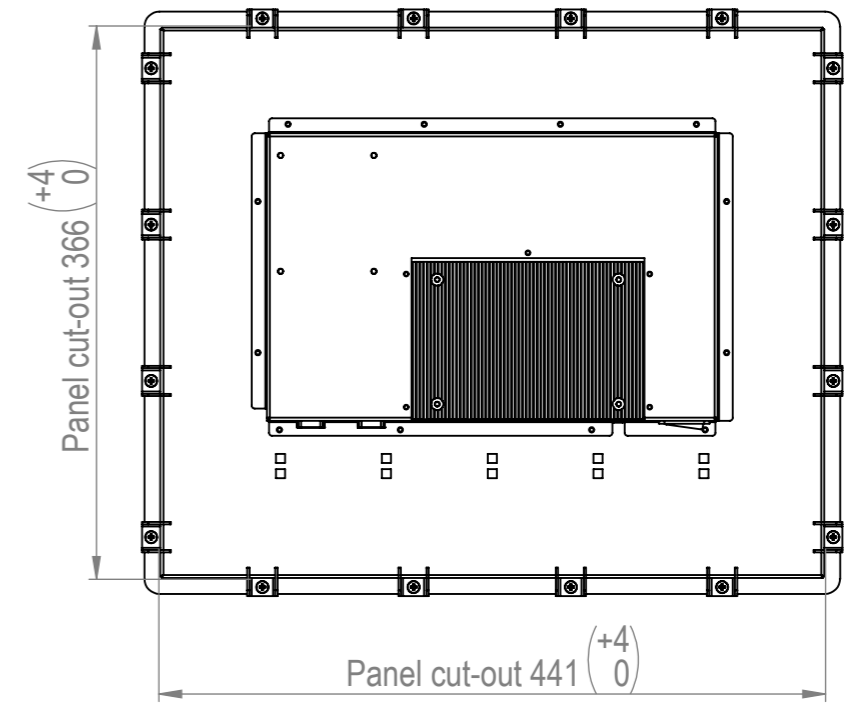
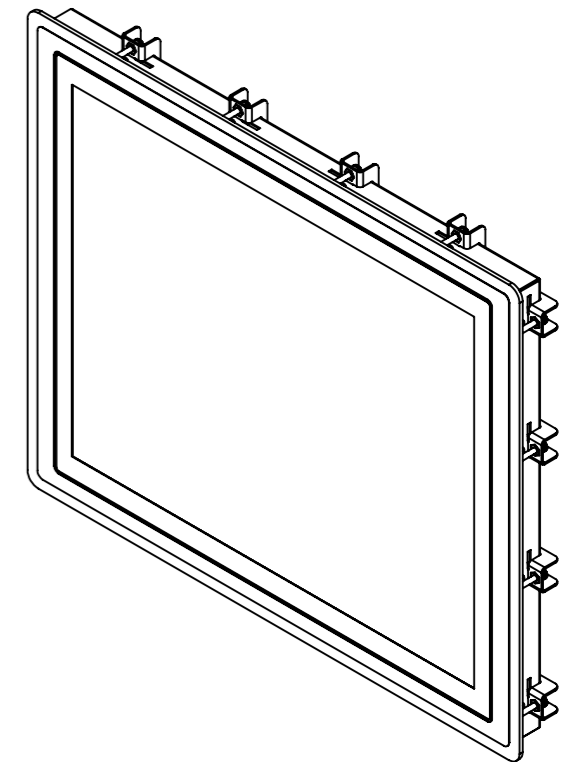
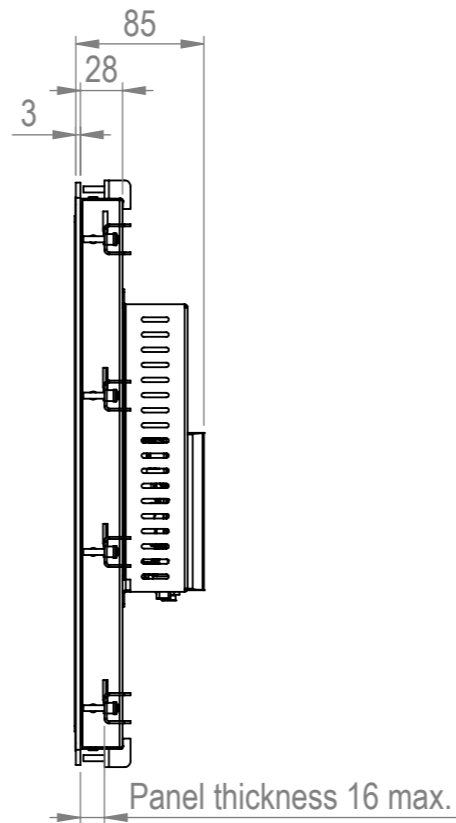
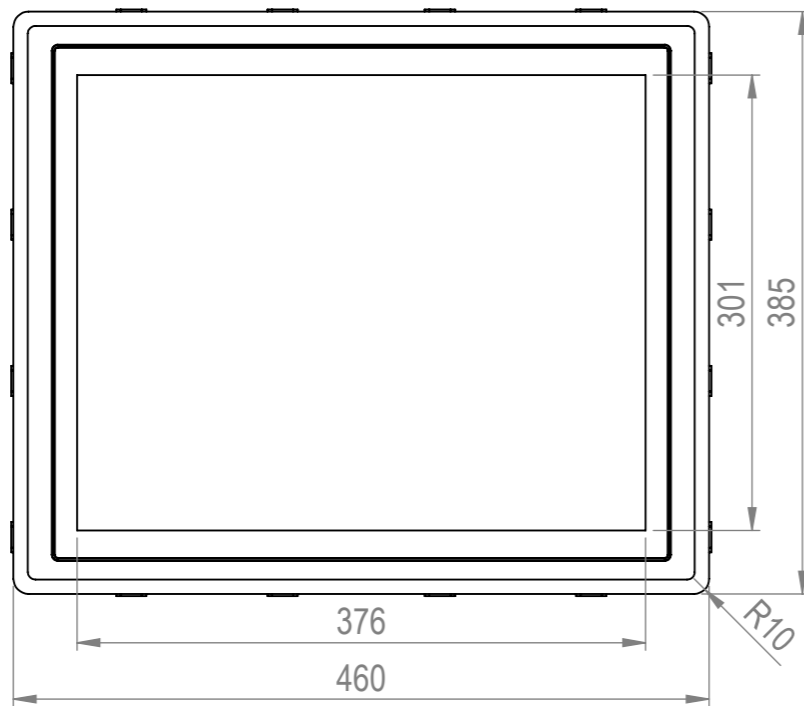
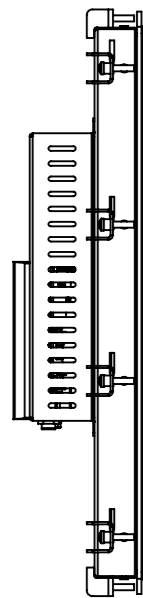
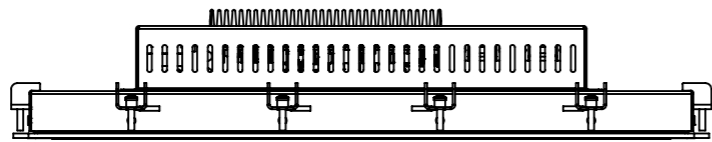

2.54mm pitch for external power button

DATE		30-8-2023		DO NOT SCALE DRAWING		DIMENSIONS ARE IN MM	
REV.	DRAWN	FB		TFT/Solutions			
3	APPROVED	FB					
MATERIAL				DESCRIPTION			
				Assembly			
FINISH				PAGE NAME			
				R190-51, i5-8265U			
				DWG NO.			
				R190-00			
				SCALE:1:5		SHEET 2 OF 3	
						A3	

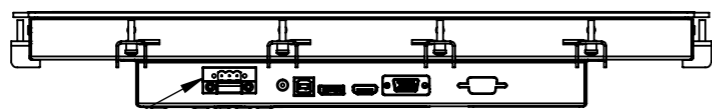
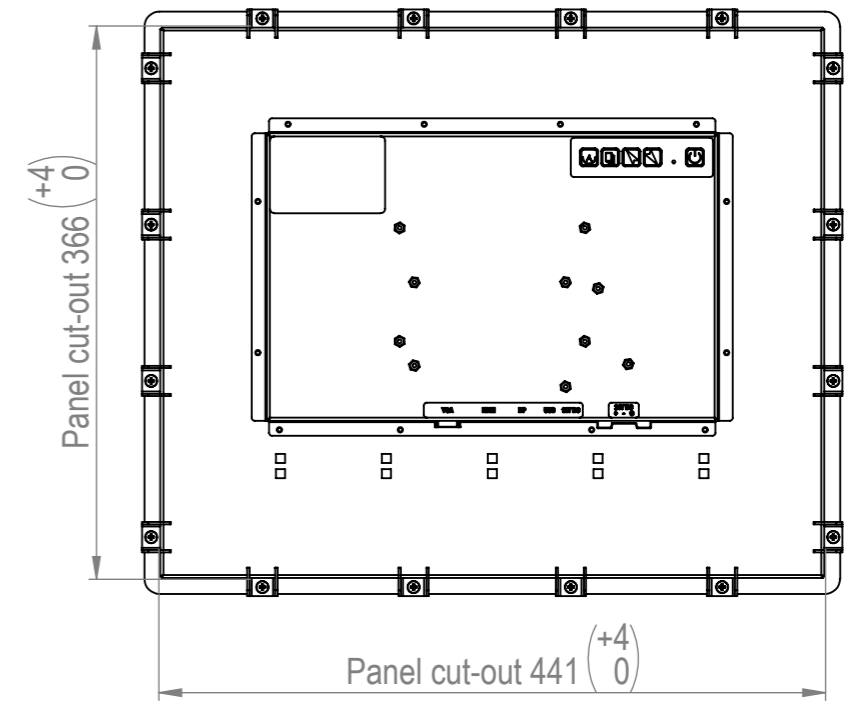
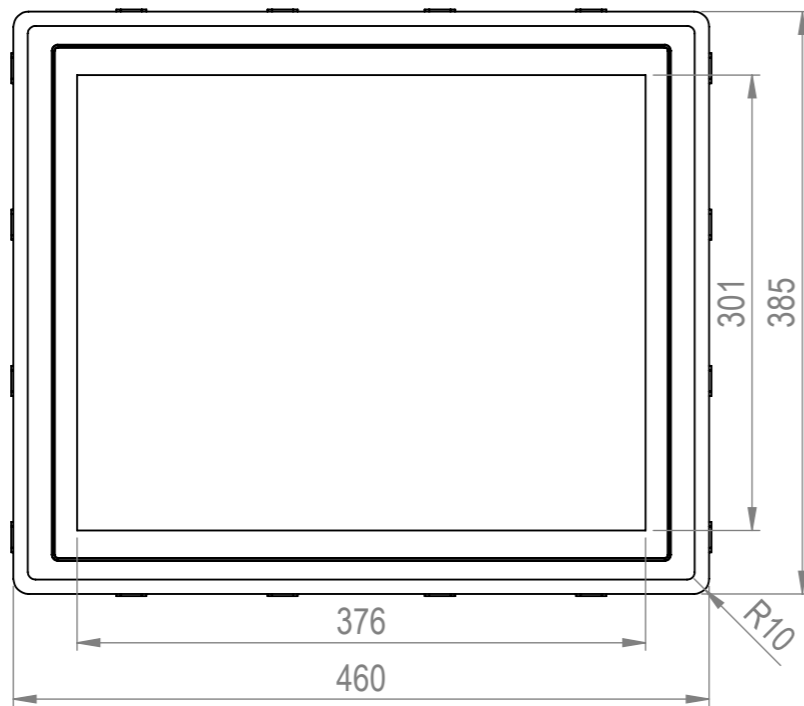
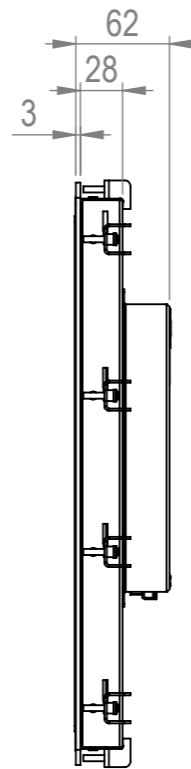
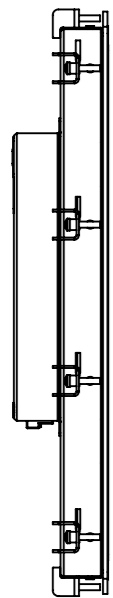
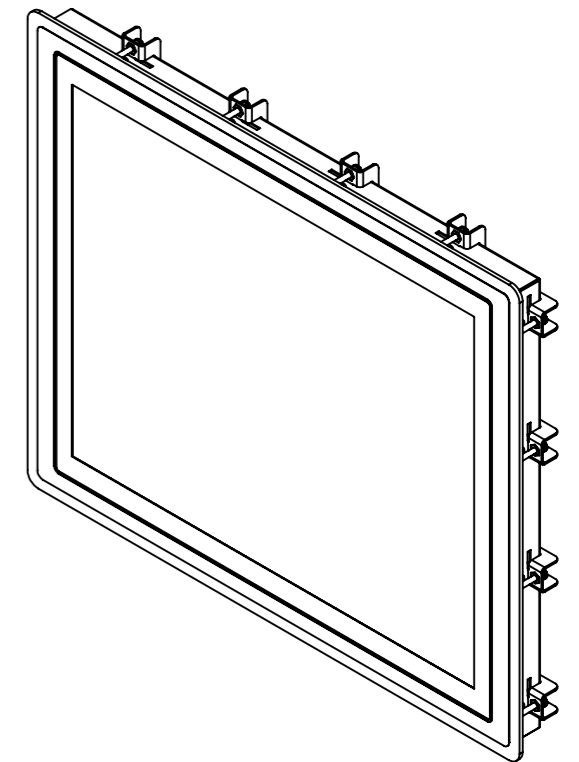
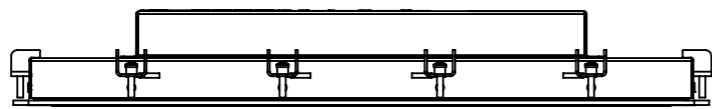

Optional 24V DC input

DATE		30-8-2023		DO NOT SCALE DRAWING		DIMENSIONS ARE IN MM	
REV.	DRAWN	FB		TFT/Solutions			
3	APPROVED	FB					
MATERIAL				DESCRIPTION			
				Assembly			
FINISH				PAGE NAME			
				R190-MON			
				DWG NO.			
				R190-00			
				SCALE:1:5		SHEET 3 OF 3	
						A3	