

2.54mm pitch for external power button

DATE		30-8-2023		DO NOT SCALE DRAWING		DIMENSIONS ARE IN MM	
REV.	DRAWN	FB		<b>TFT/Solutions</b>			
5	APPROVED	FB					
MATERIAL				DESCRIPTION			
				Assembly			
FINISH				PAGE NAME			
				R215-C4, Celeron J6412			
				DWG NO.			
				R215-00			
				SCALE:1:5		SHEET 1 OF 3	
						A3	

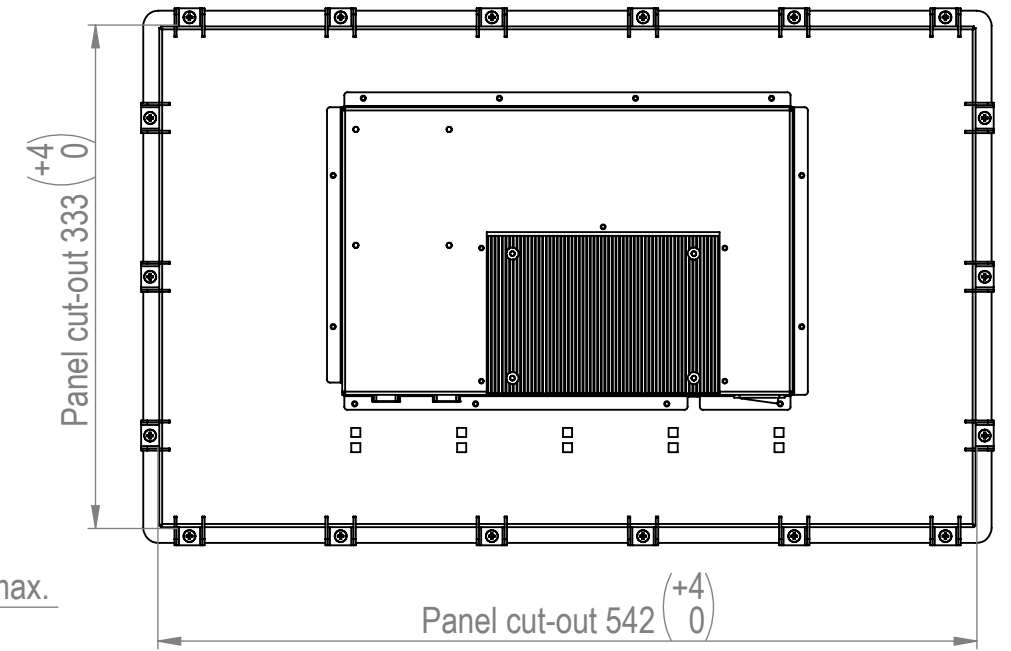
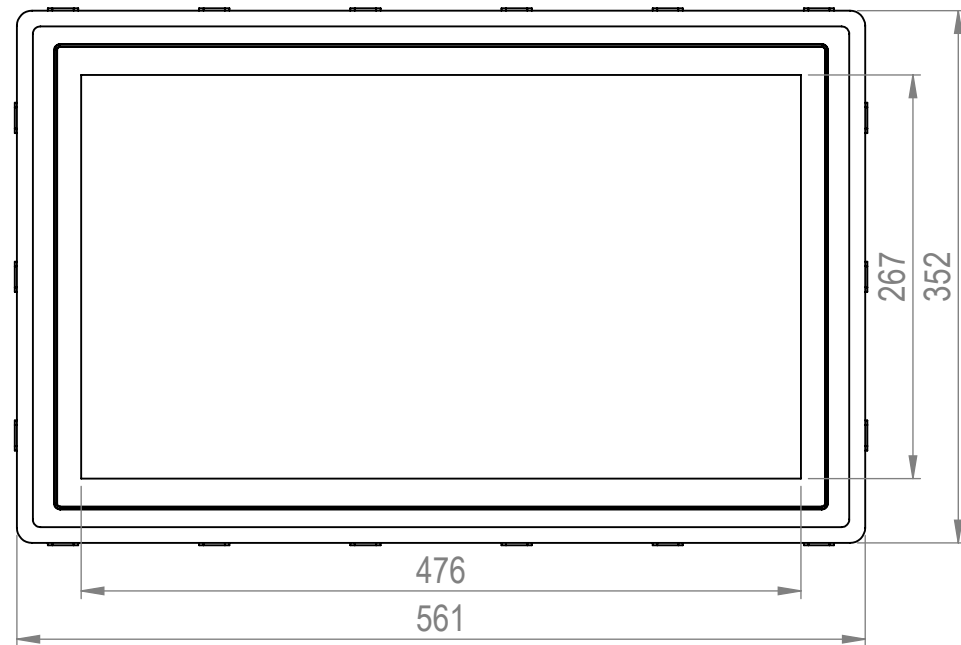
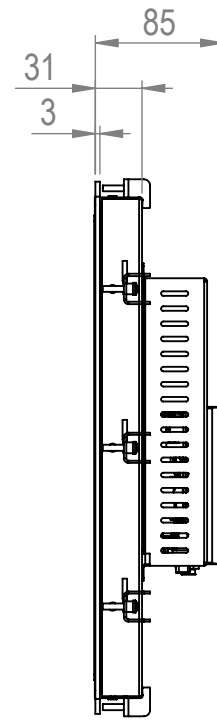
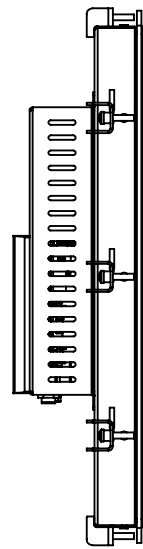
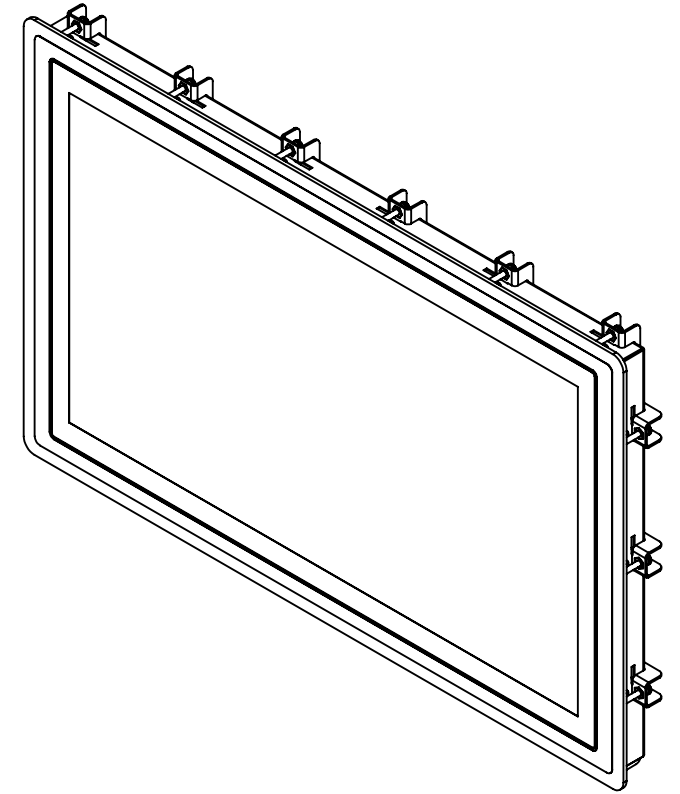
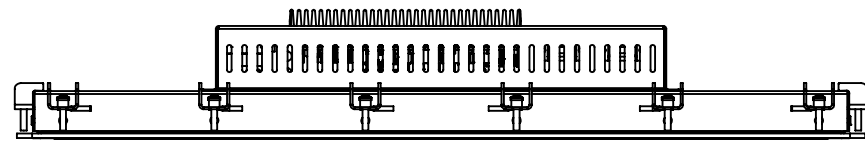

Panel thickness 16 max.

2.54mm pitch for external power button

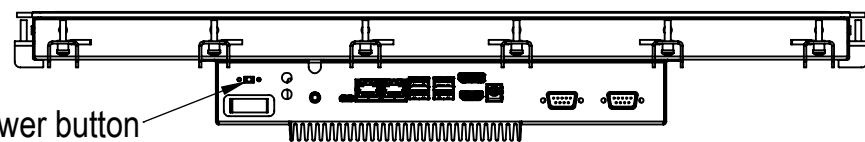

DATE		30-8-2023		DO NOT SCALE DRAWING		DIMENSIONS ARE IN MM	
REV.	DRAWN	FB		<b>TFT/Solutions</b>			
5	APPROVED	FB					
MATERIAL				DESCRIPTION			
				Assembly			
FINISH				PAGE NAME			
				R215-51, i5-8265U			
				DWG NO.			
				R215-00			
				SCALE:1:5		SHEET 2 OF 3	
						A3	

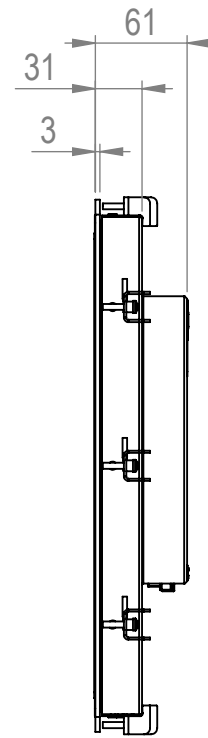
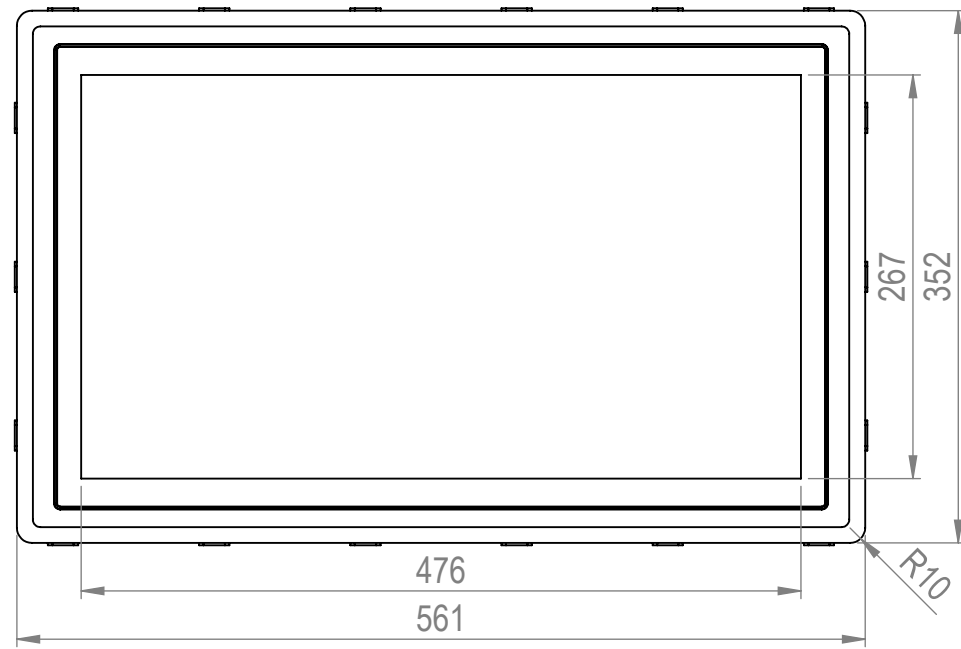
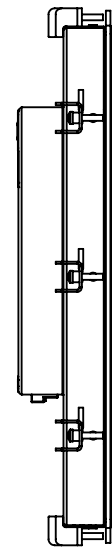
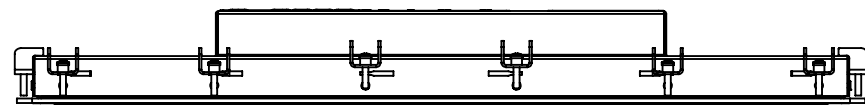

Panel thickness 16 max.

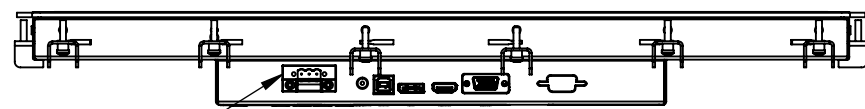
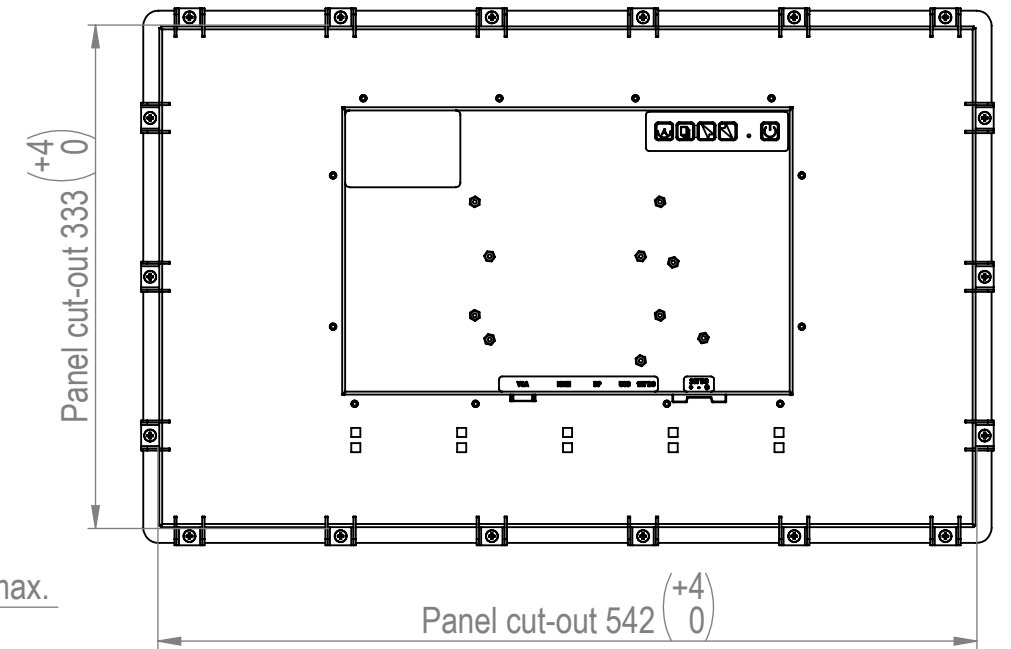
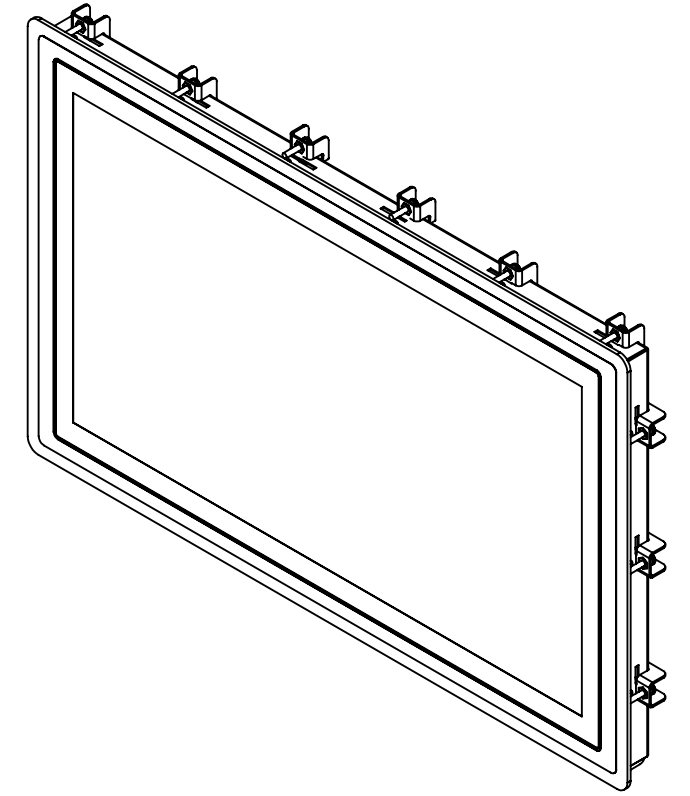

Optional 24V DC input

DATE		30-8-2023		DO NOT SCALE DRAWING		DIMENSIONS ARE IN MM	
REV.	DRAWN	FB		<b>TFT/Solutions</b>			
5	APPROVED	FB					
MATERIAL				DESCRIPTION			
				Assembly			
FINISH				PAGE NAME			
				R215-MON			
				DWG NO.			
				R215-00			
				SCALE:1:5		SHEET 3 OF 3	
						A3	