

DATE		21-10-2023		DO NOT SCALE DRAWING		DIMENSIONS ARE IN MM	
REV.	DRAWN	FB		TFT/Solutions			
1	APPROVED	FB					
MATERIAL		SS316 housing Toughened glass		DESCRIPTION Assembly			
FINISH		Brushed		PAGE NAME		K170-C4, Celeron J6412	
				DWG NO.		K170-00	
				SCALE:1:5		SHEET 1 OF 2	
						A3	

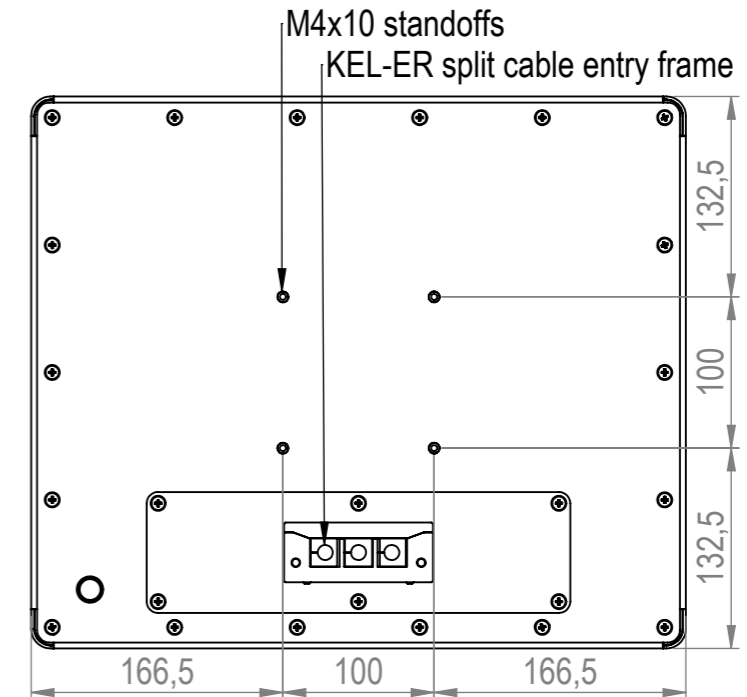
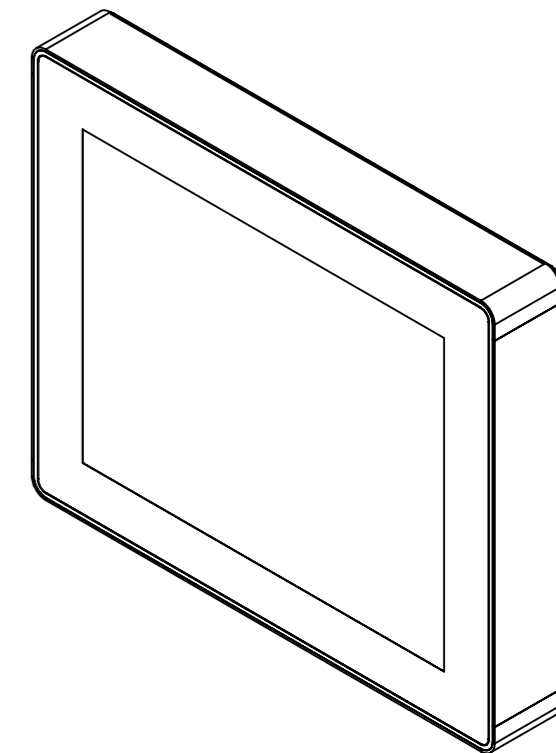
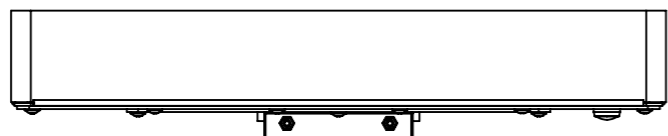
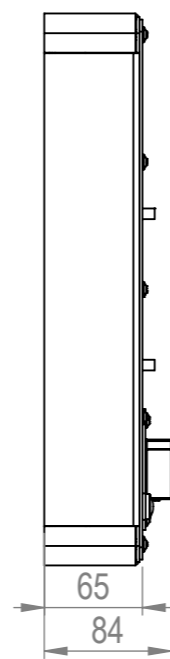
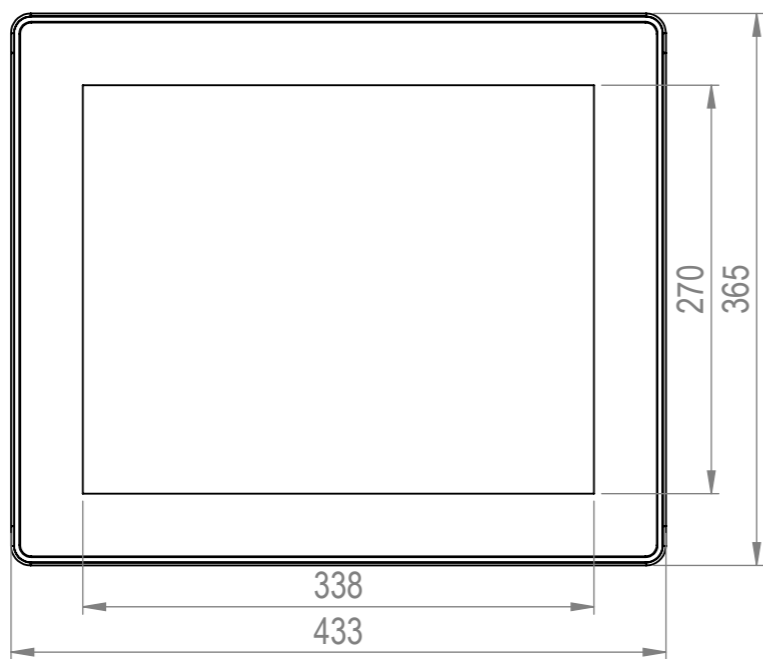
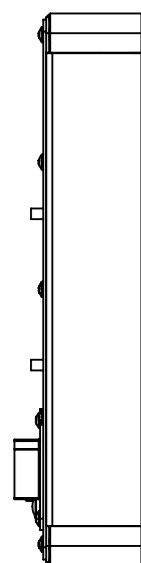
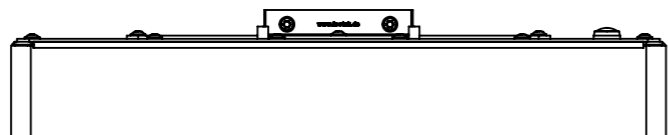

DATE		21-10-2023		DO NOT SCALE DRAWING		DIMENSIONS ARE IN MM	
REV.	DRAWN	FB		TFT/Solutions			
1	APPROVED	FB					
MATERIAL		SS316 housing Toughened glass		DESCRIPTION Assembly			
FINISH		Brushed		PAGE NAME K170-MON			
				DWG NO. K170-00			
				SCALE:1:5		SHEET 2 OF 2	
						A3	