

DATE		21-10-2023		DO NOT SCALE DRAWING		DIMENSIONS ARE IN MM	
REV.	DRAWN	FB		<b>TFT/Solutions</b>			
1	APPROVED	FB					
MATERIAL		SS316 housing Toughened glass		DESCRIPTION Assembly			
FINISH		Brushed		PAGE NAME K215-C4, Celeron J6412			
				DWG NO.		A3	
				SCALE:1:5		SHEET 1 OF 2	
				K215-00			

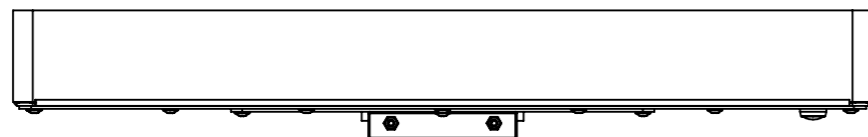
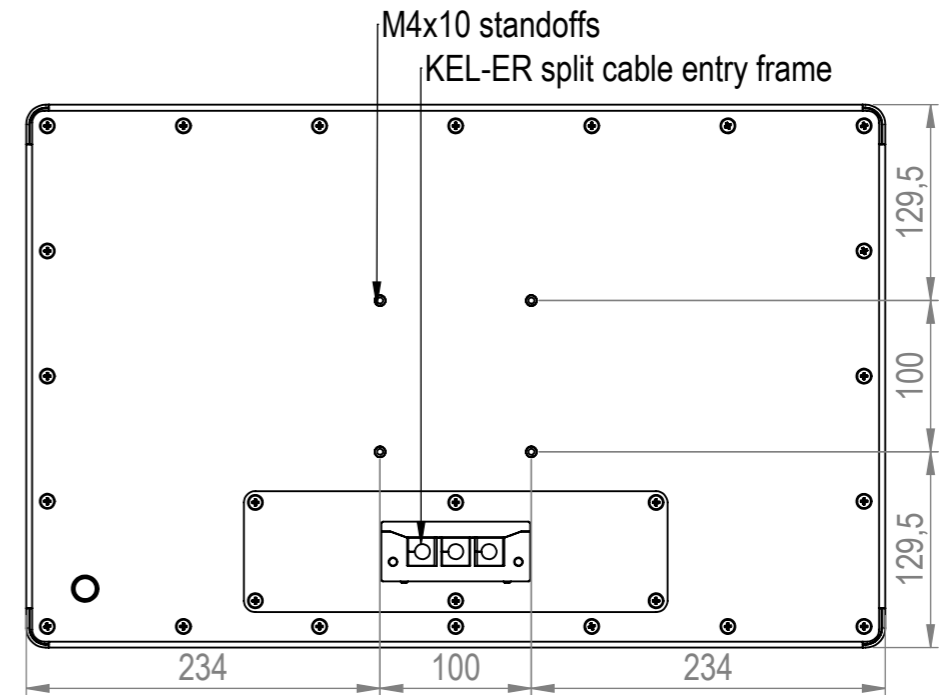
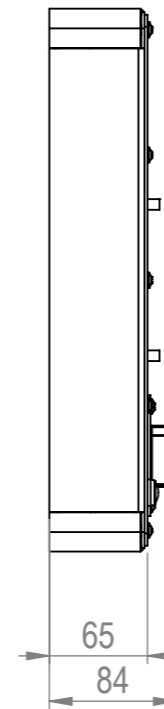
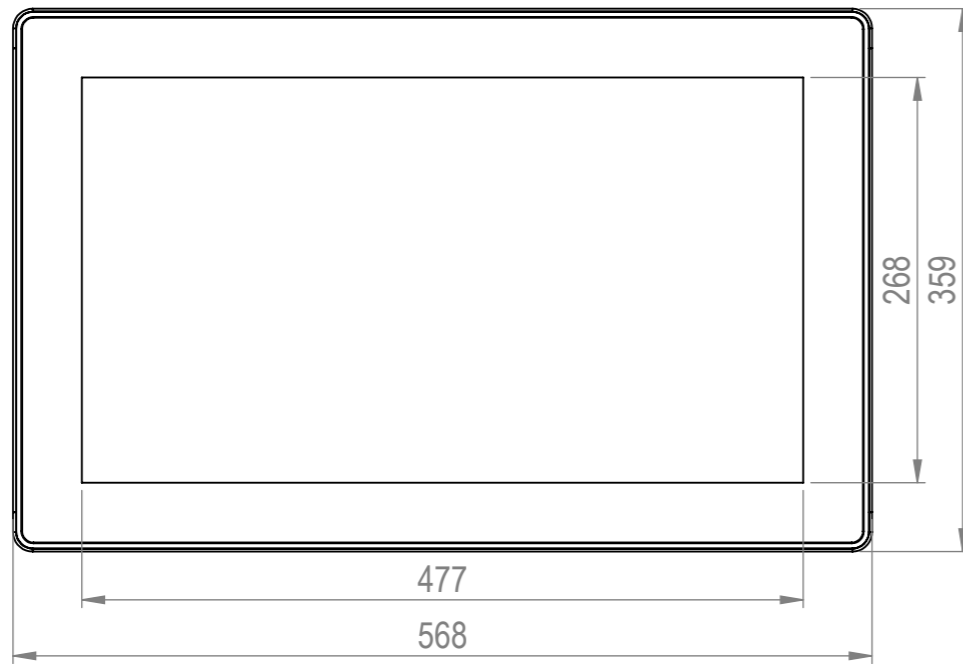
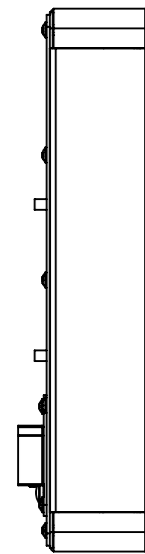
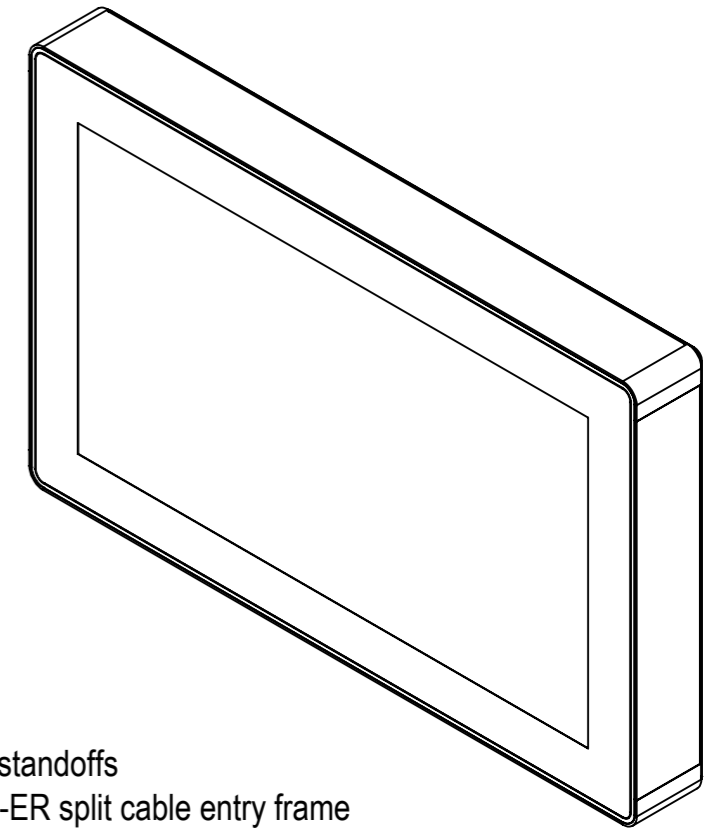
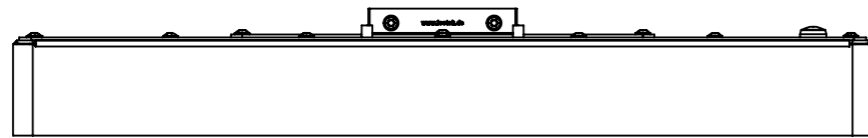

DATE		21-10-2023		DO NOT SCALE DRAWING		DIMENSIONS ARE IN MM	
REV.	DRAWN	FB		<b>TFT/Solutions</b>			
1	APPROVED	FB					
MATERIAL		SS316 housing Toughened glass		DESCRIPTION Assembly			
FINISH		Brushed		PAGE NAME K215-MON			
				DWG NO. K215-00			
				SCALE:1:5		SHEET 2 OF 2	
						A3	